

Hong Kong Gifts & Premium Fair

香港禮品及贈品展

5M x 3M WORLD OF GIFT IDEAS BOOTH

五米乘三米精品薈萃展台

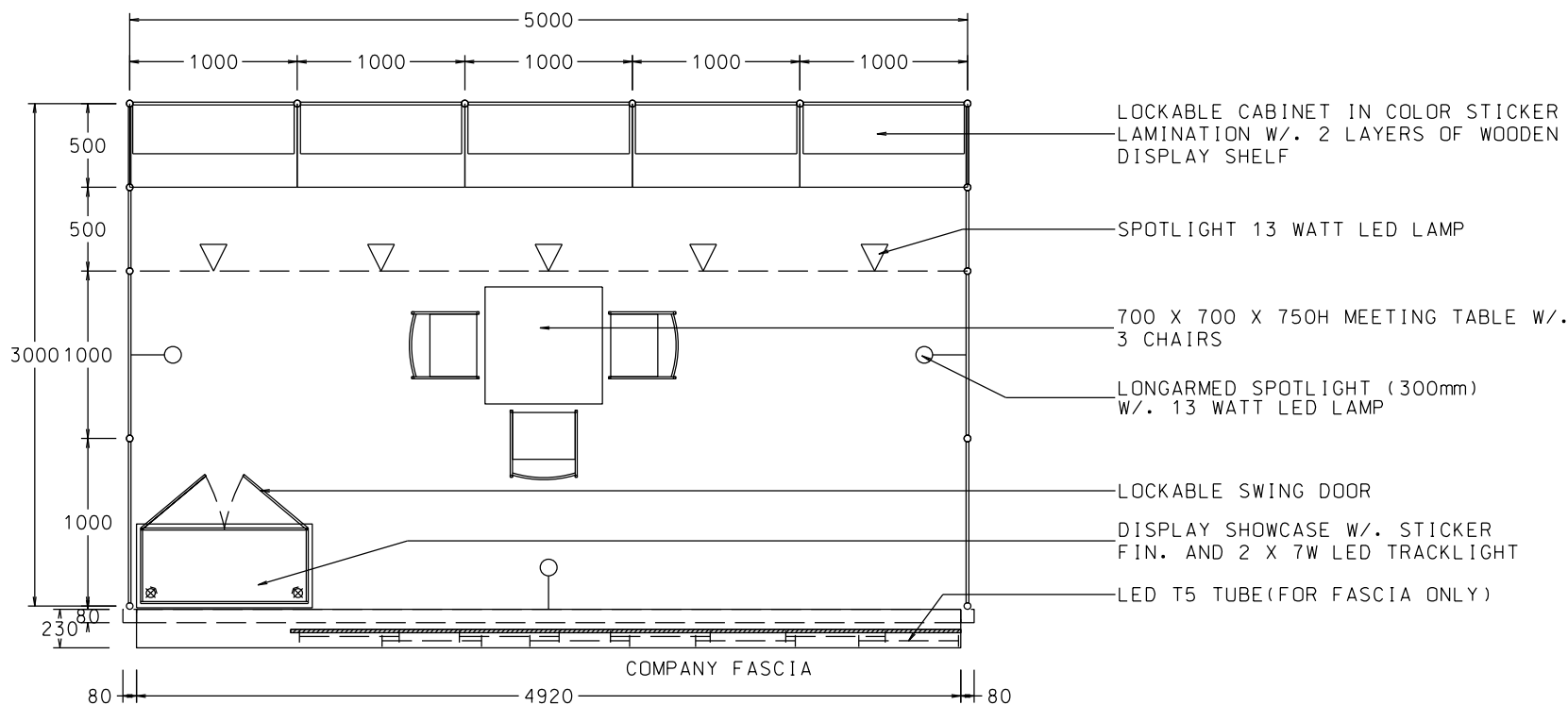

PLAN

PERSPECTIVE

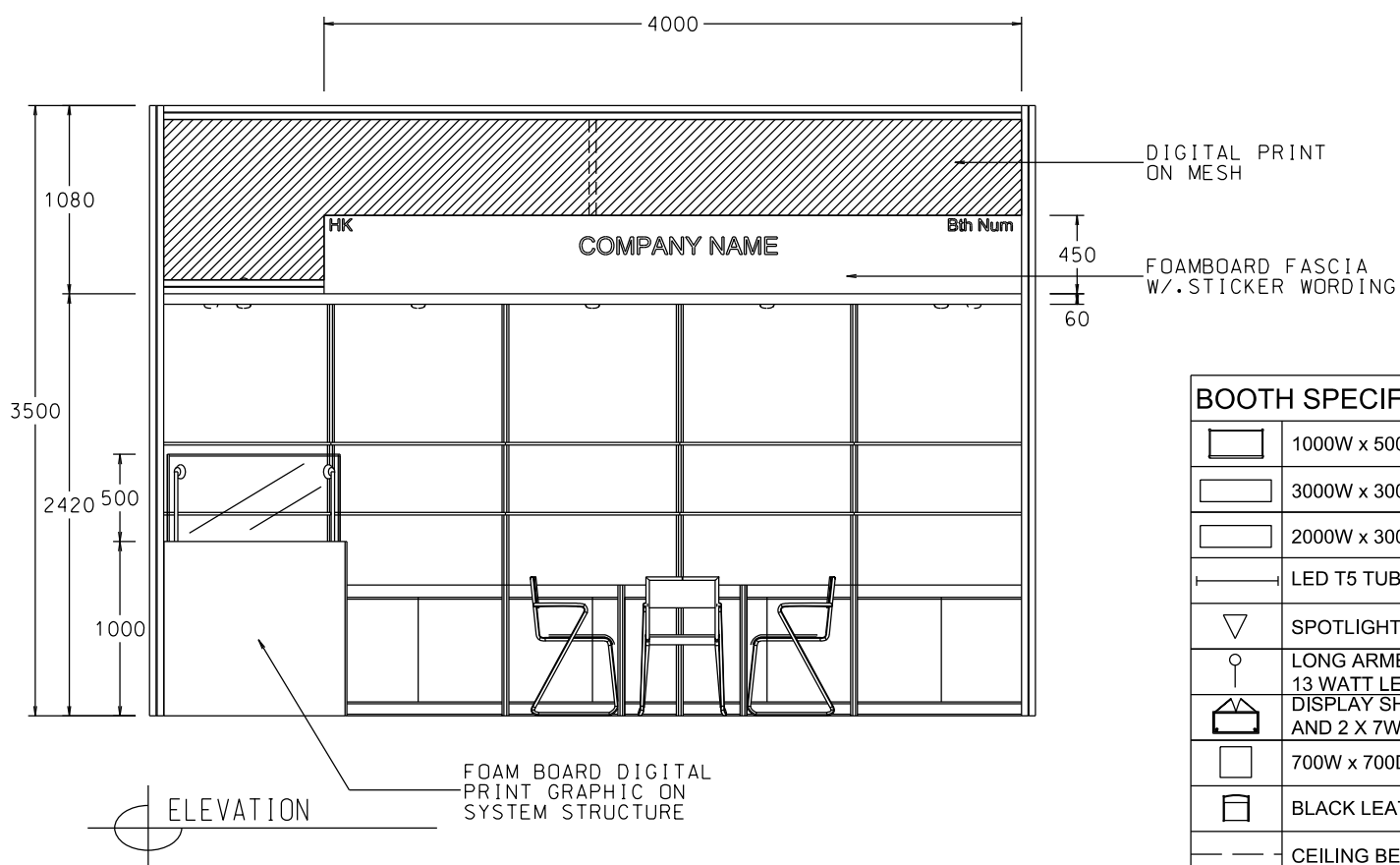
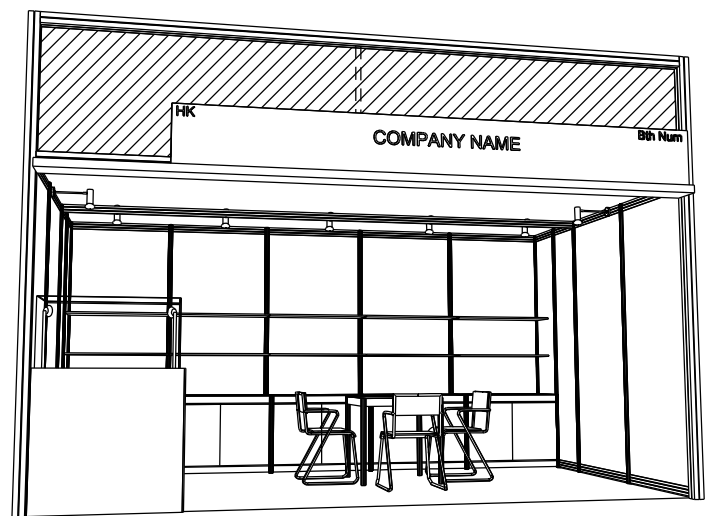

ELEVATION

BOOTH SPECIFICATIONS		QTY.
	1000W x 500D x 750H LOCKABLE CABINET	5
	3000W x 300D WOODEN DISPLAY SHELF	2
	2000W x 300D WOODEN DISPLAY SHELF	2
	LED T5 TUBE (FOR FASCIA ONLY)	8
	SPOTLIGHT 13 WATT LED LAMP (YELLOW LIGHT)	5
	LONG ARMED SPOTLIGHT (300MM) 13 WATT LED LAMP (YELLOW LIGHT)	3
	DISPLAY SHOWCASE W/. STICKER FIN. AND 2 X 7W LED TRACKLIGHT	1
	700W x 700D x 750H MEETING TABLE	1
	BLACK LEATHER CHAIR	3
	CEILING BEAM	5M
	RUBBISH BIN & CARPET (15sqm.)	

Hong Kong Gifts & Premium Fair

香港禮品及贈品展

5M x 3M WORLD OF GIFT IDEAS LEFT CORNER BOOTH

五米乘三米左邊角位精品薈萃展台

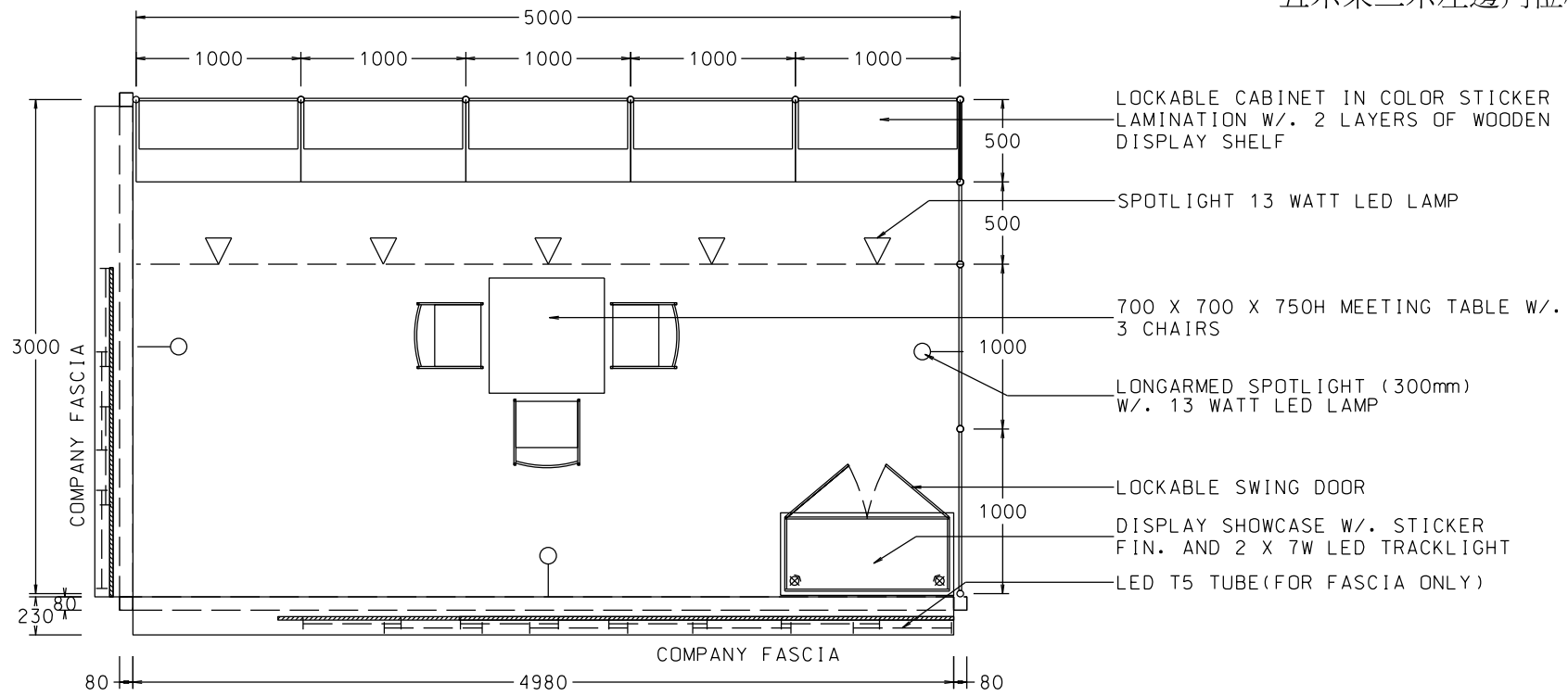

PLAN

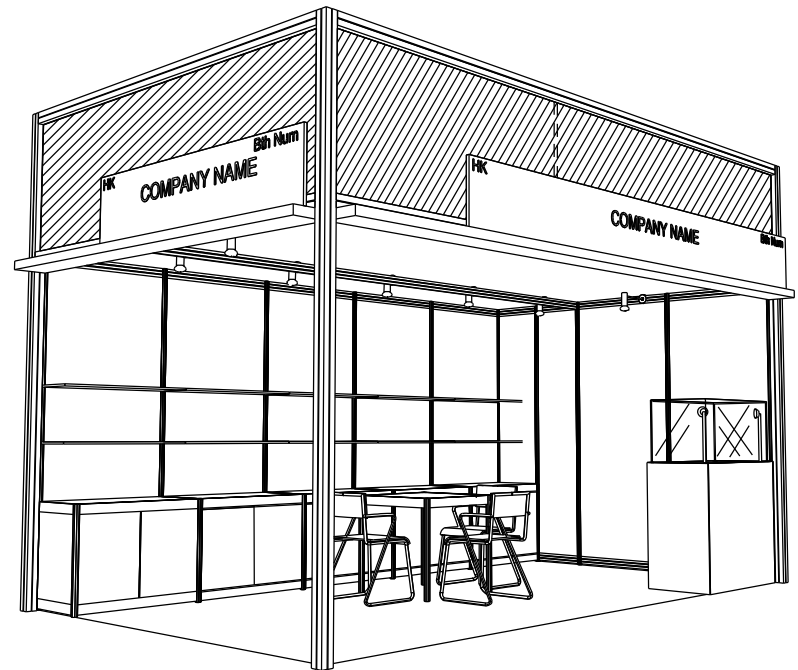

PERSPECTIVE

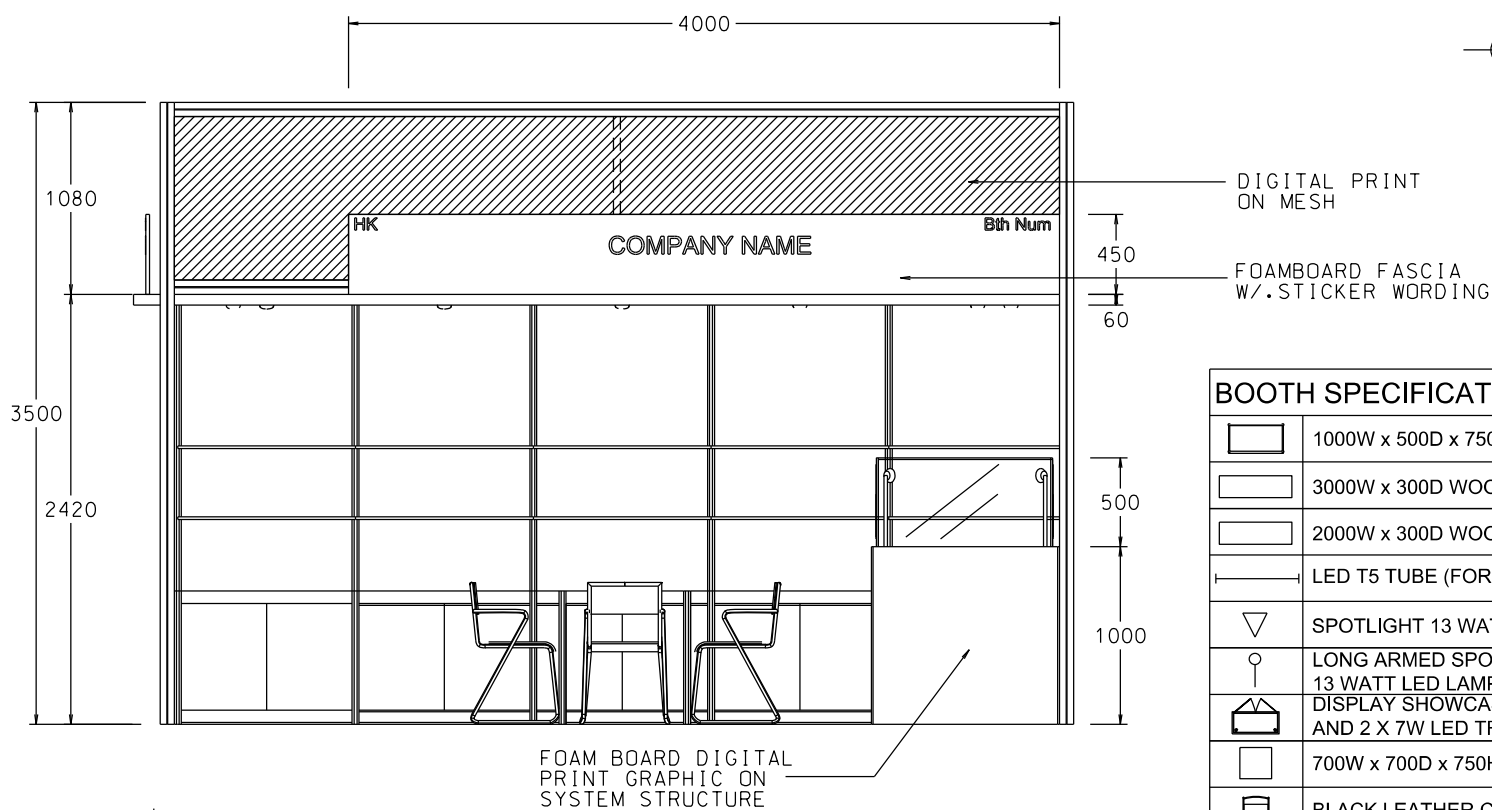

ELEVATION

BOOTH SPECIFICATIONS		QTY.
	1000W x 500D x 750H LOCKABLE CABINET	5
	3000W x 300D WOODEN DISPLAY SHELF	2
	2000W x 300D WOODEN DISPLAY SHELF	2
	LED T5 TUBE (FOR FASCIA ONLY)	12
	SPOTLIGHT 13 WATT LED LAMP (YELLOW LIGHT)	5
	LONG ARMED SPOTLIGHT (300MM) 13 WATT LED LAMP (YELLOW LIGHT)	3
	DISPLAY SHOWCASE W/. STICKER FIN. AND 2 X 7W LED TRACKLIGHT	1
	700W x 700D x 750H MEETING TABLE	1
	BLACK LEATHER CHAIR	3
	CEILING BEAM	5M
	RUBBISH BIN & CARPET (15sqm.)	

5M x 3M WORLD OF GIFT IDEAS RIGHT CORNER BOOTH

五米乘三米右邊角位精品薈萃展台

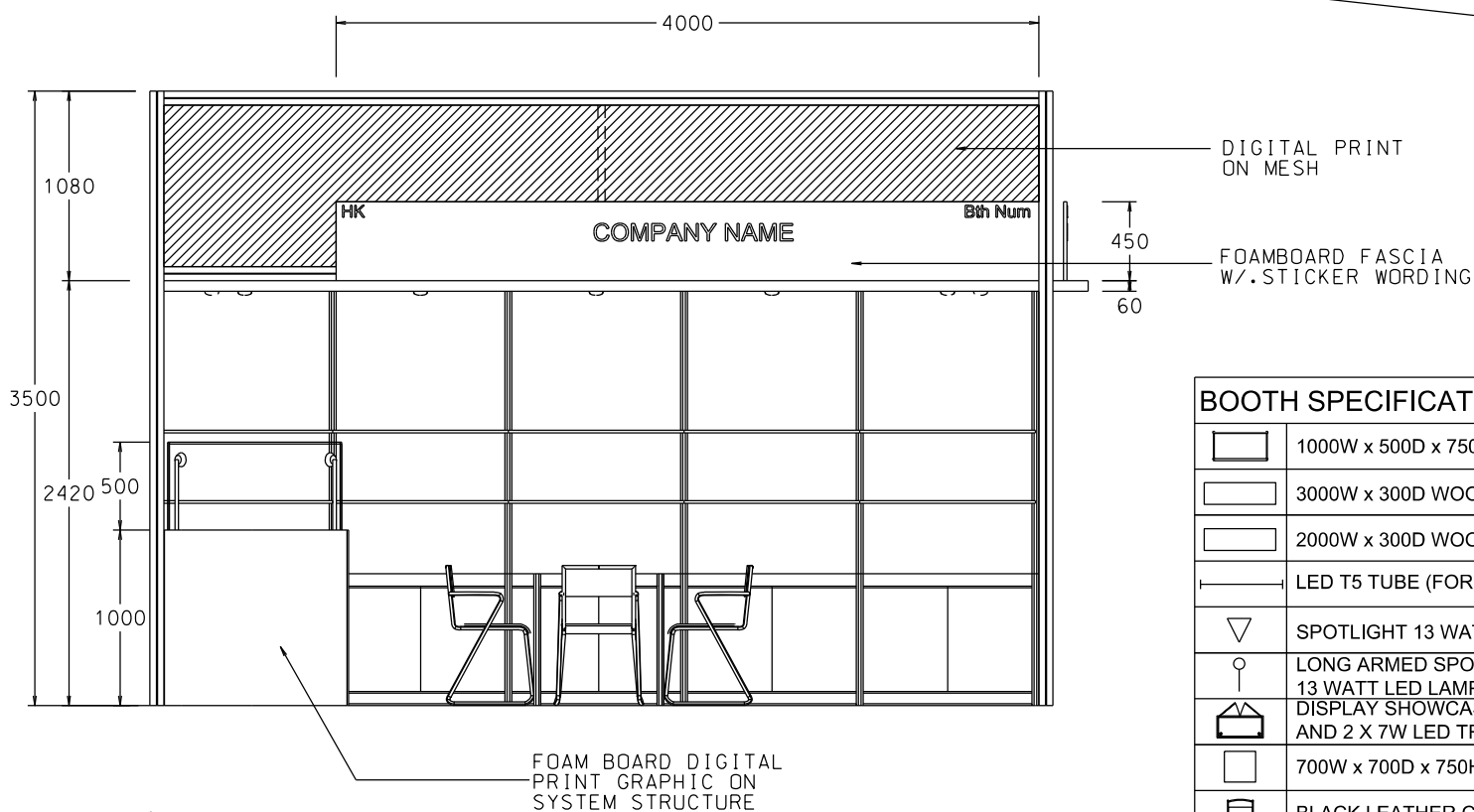
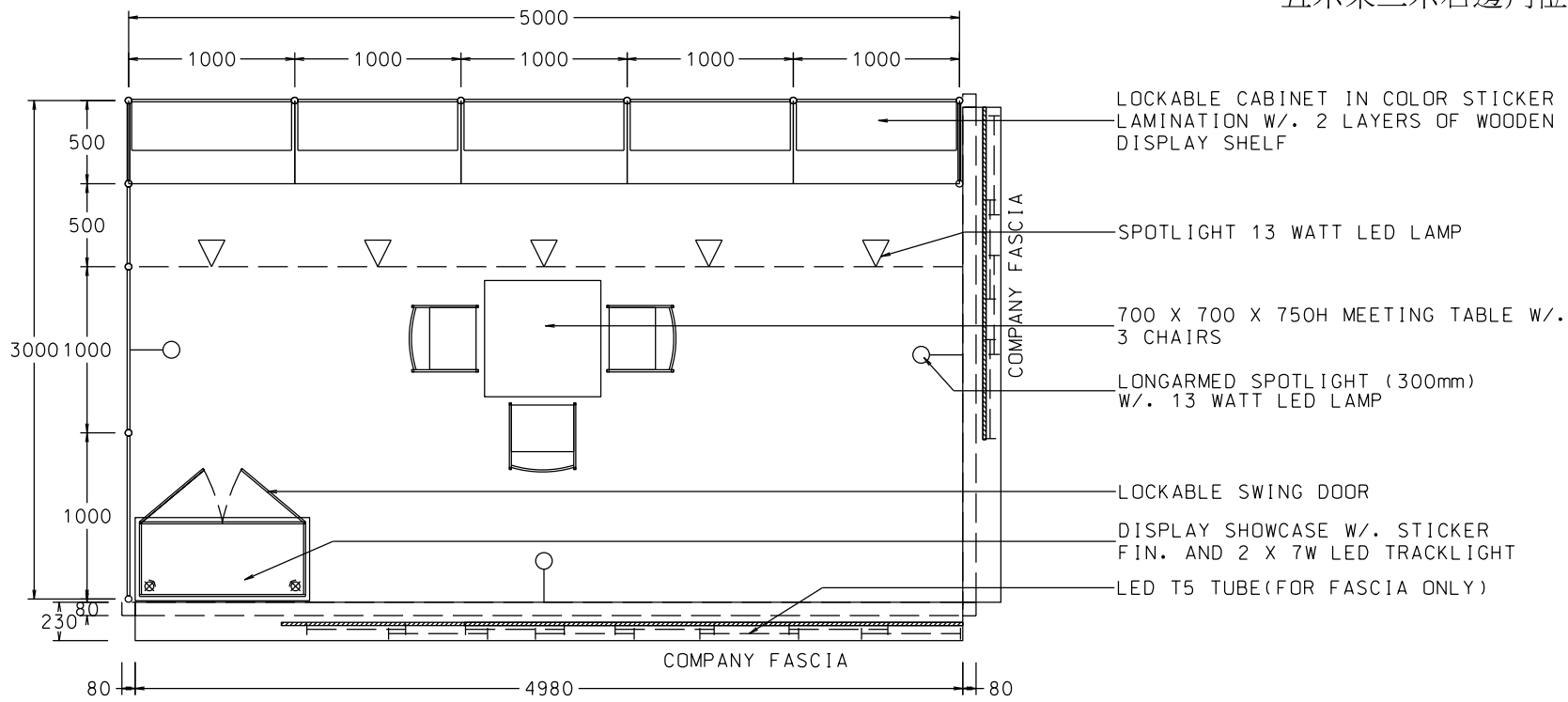

BOOTH SPECIFICATIONS		QTY.
	1000W x 500D x 750H LOCKABLE CABINET	5
	3000W x 300D WOODEN DISPLAY SHELF	2
	2000W x 300D WOODEN DISPLAY SHELF	2
	LED T5 TUBE (FOR FASCIA ONLY)	12
	SPOTLIGHT 13 WATT LED LAMP (YELLOW LIGHT)	5
	LONG ARMED SPOTLIGHT (300MM) 13 WATT LED LAMP (YELLOW LIGHT)	3
	DISPLAY SHOWCASE W/. STICKER FIN. AND 2 X 7W LED TRACKLIGHT	1
	700W x 700D x 750H MEETING TABLE	1
	BLACK LEATHER CHAIR	3
	CEILING BEAM	5M
	RUBBISH BIN & CARPET (15sqm.)	

Hong Kong Gifts & Premium Fair

香港禮品及贈品展

5M x 3M WORLD OF GIFT IDEAS RIGHT CORNER BOOTH (UNDER FIRE SHUTTER)

防火閘下五米乘三米右邊角位精品薈萃展台

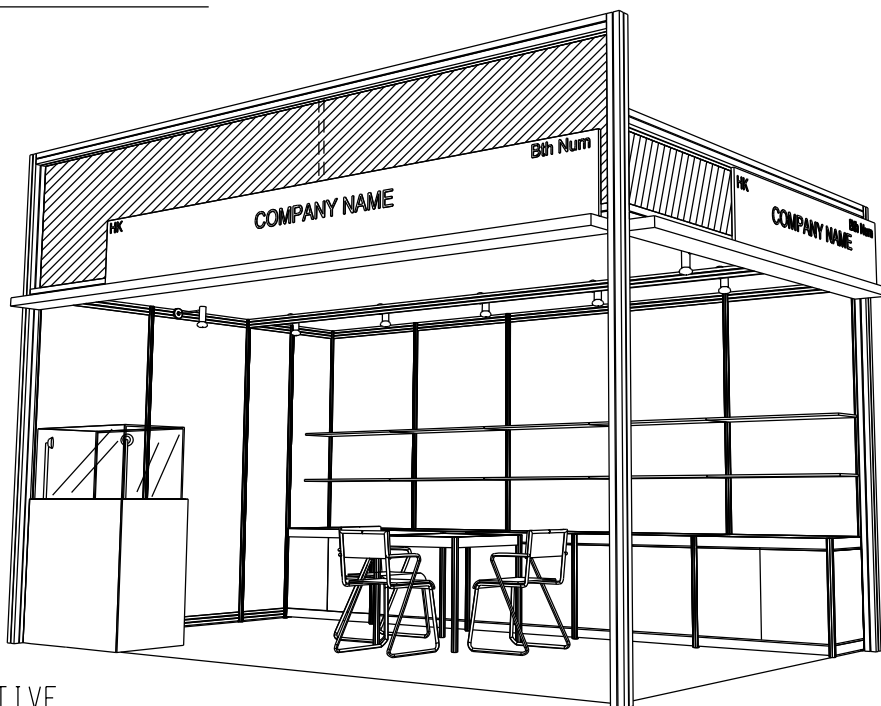
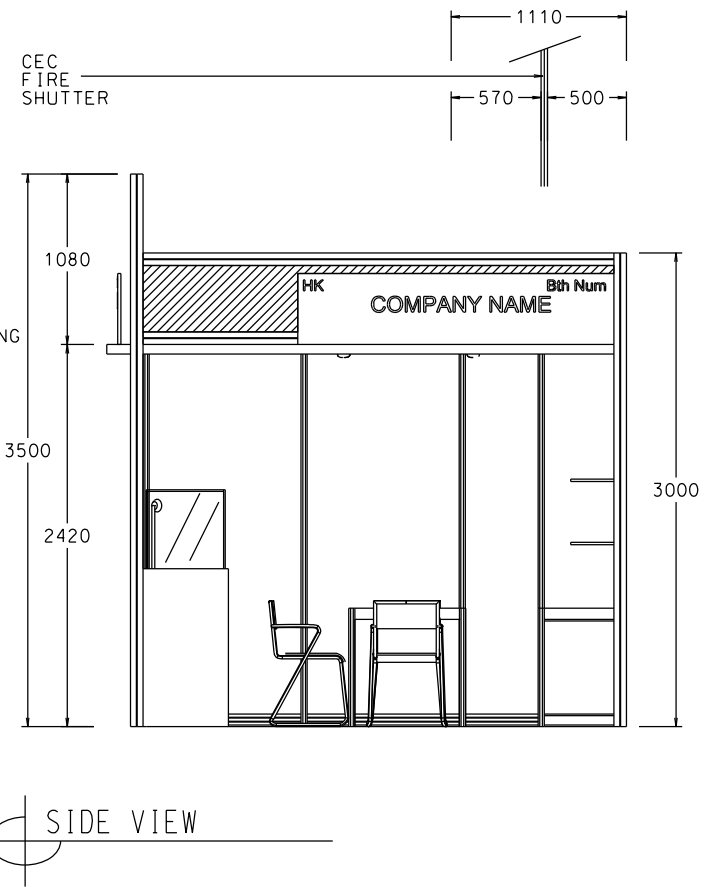
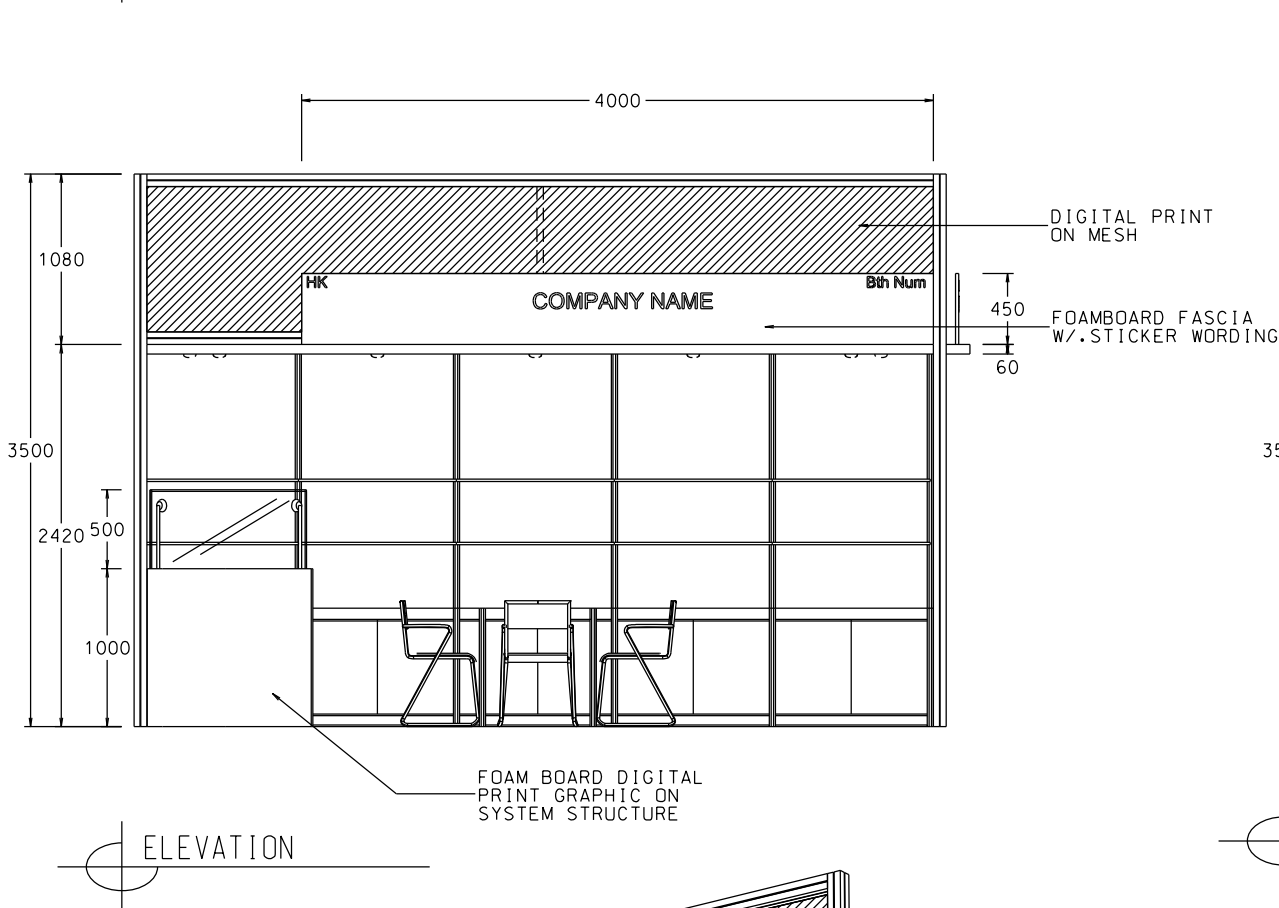
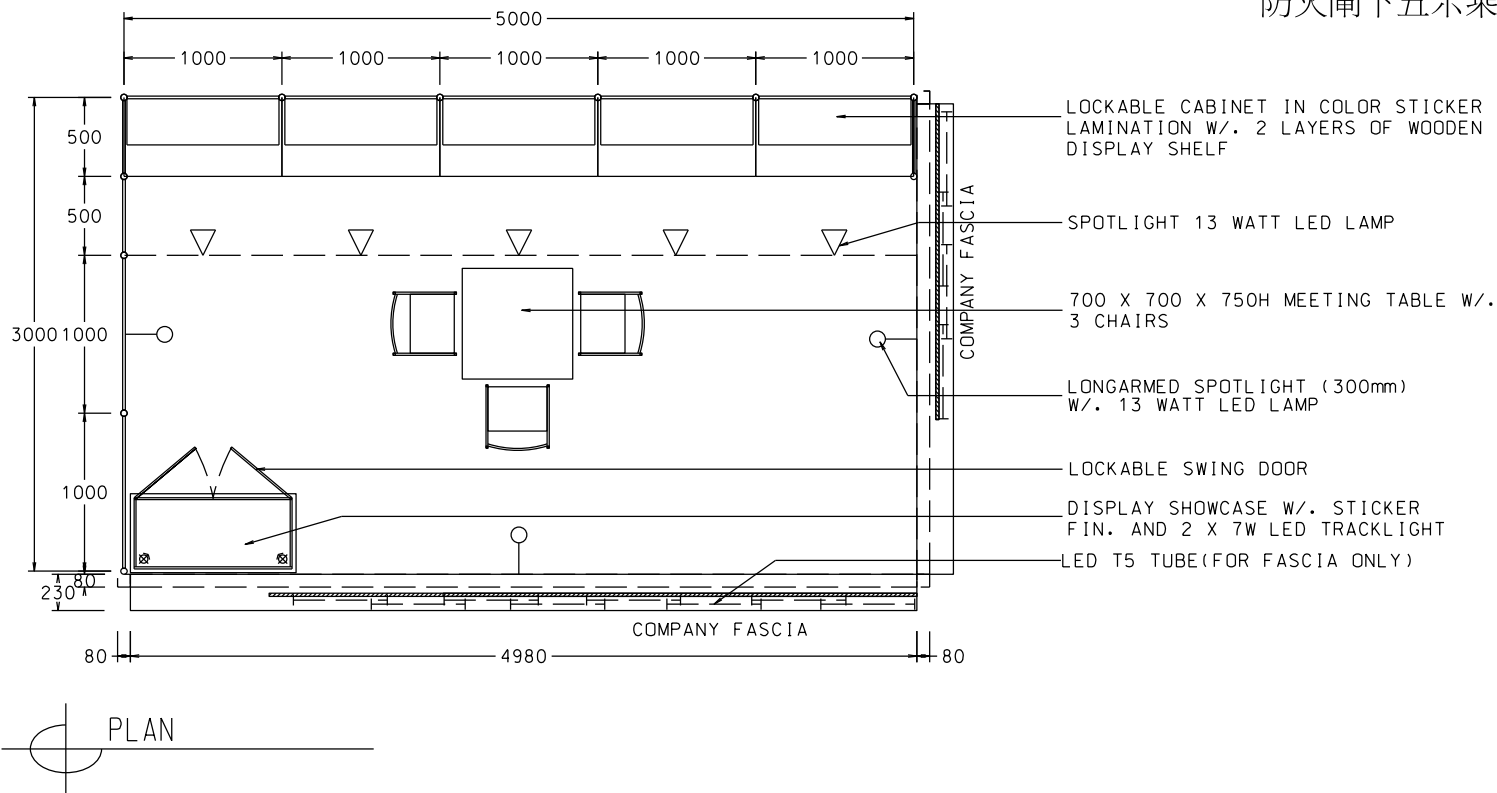

BOOTH SPECIFICATIONS		QTY.
	1000W x 500D x 750H LOCKABLE CABINET	5
	3000W x 300D WOODEN DISPLAY SHELF	2
	2000W x 300D WOODEN DISPLAY SHELF	2
	LED T5 TUBE(FOR FASCIA ONLY)	12
	SPOTLIGHT 13 WATT LED LAMP (YELLOW LIGHT)	5
	LONG ARMED SPOTLIGHT (300MM) 13 WATT LED LAMP (YELLOW LIGHT)	3
	DISPLAY SHOWCASE W/. STICKER FIN. AND 2 X 7W LED TRACKLIGHT	1
	700W x 700D x 750H MEETING TABLE	1
	BLACK LEATHER CHAIR	3
	CEILING BEAM	5M
	RUBBISH BIN & CARPET (15sqm.)	